

□

单位名称：江苏托球农化股份有限公司

注册地址：江苏滨海经济开发区沿海工业园开泰路

行业类别：化学农药制造

生产经营场所地址：江苏滨海经济开发区沿海工业园开泰路

统一社会信用代码：91320900748728296A

法定代表人（主要负责人）：廖大章

技术负责人：孙伯文

固定电话：0515-84383171

移动电话：13770050291

企业盖章：

申请日期：2020年12月04日



□



2020320



20203206

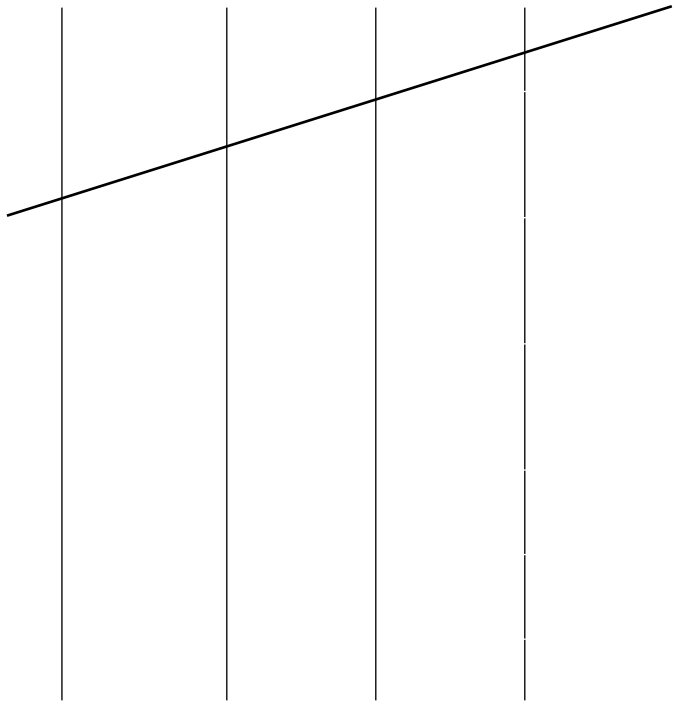

2020320



20203206



2020320



2020320



2020320



2020320



2020320



2020320





2020320





2020320



2020320



2020320



2020320



2020320







2020320



2020320



20203206



2020320



20203208



2020320



2020320

□ □



2020320



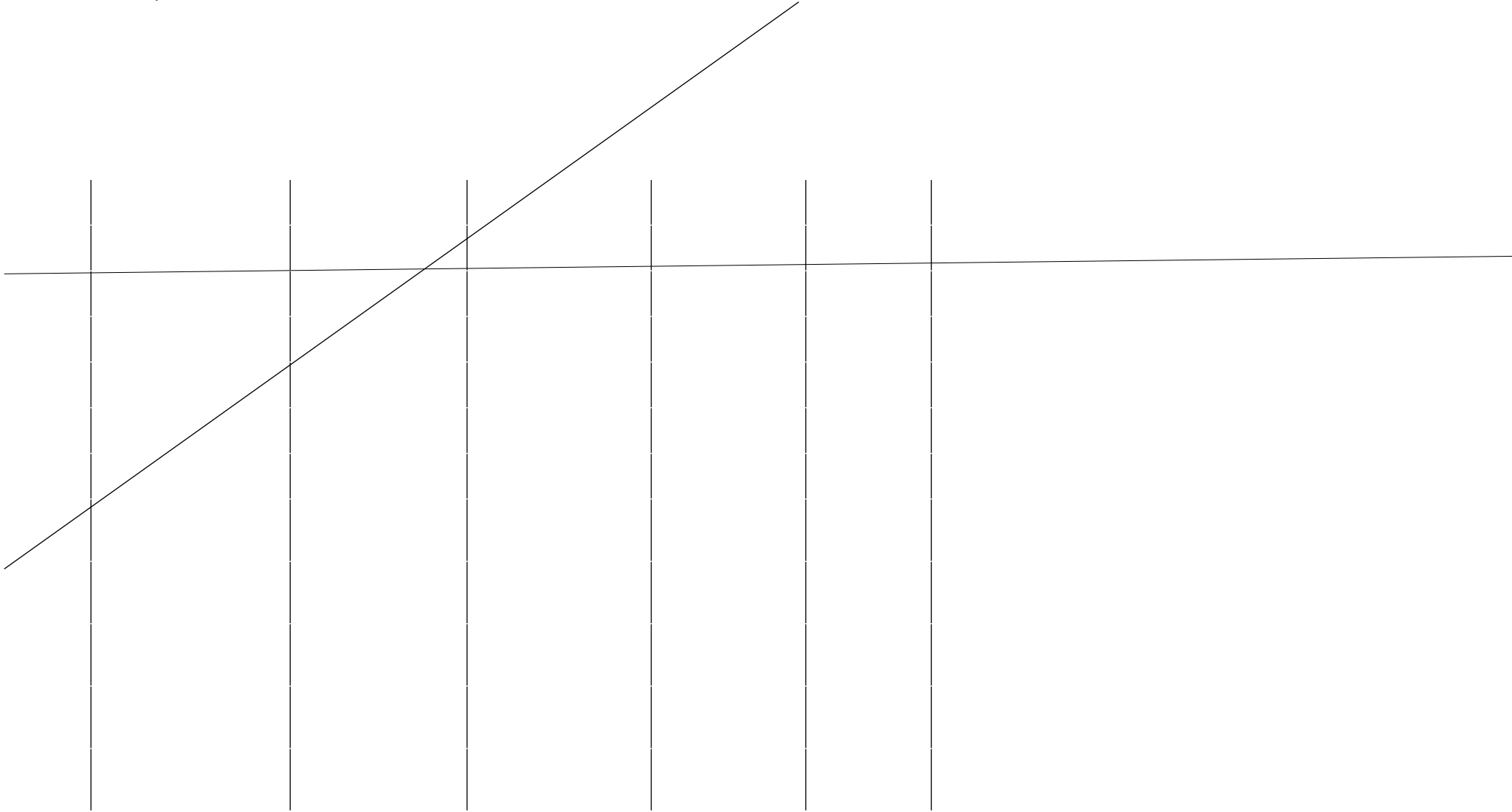

2020320



□ □ □ □



2020320



2020320



2020320



2020320



2020320



2020320



20203206



2020320



20203206



2020320



2020320

e ! f

2020320



2020320



20203206

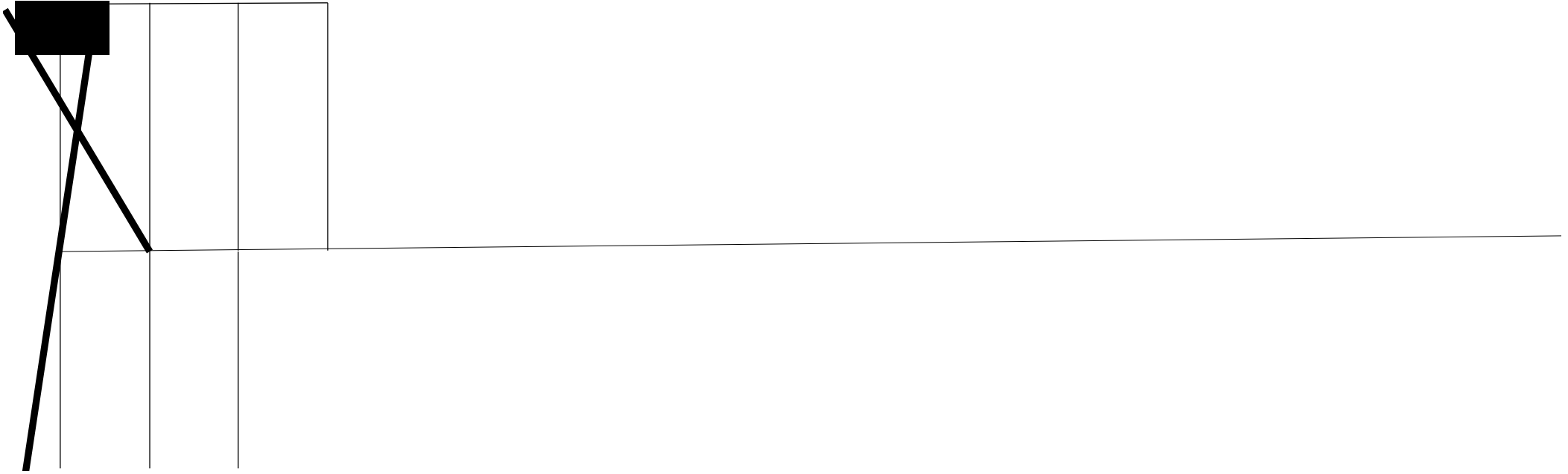

2020320



2020320



2020320



2020320



20203206



2020320



2020320



2020320



20203206



2020320



20203206



20203206



2020320

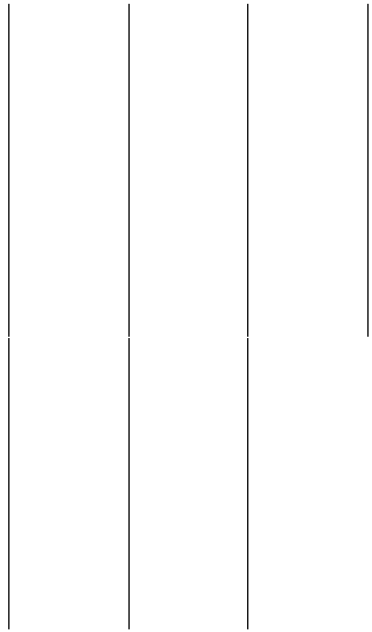

20203206



20203206



2020320



2020320



2020320



20203206



2020320



2020320

b c
d





2020320



2020320



2020320



2020320



2020320



20203206



2020320



2020320





2020320



2020320



2020320



2020320



2020320



20203206



2020320



2020320



2020320



2020320



2020320



2020320



2020320



2020320



2020320



2020320



20203206



2020320



20203206



2020320



2020320



20203206



20203206



2020320



2020320



20203206



20203206



2020320



20203206



20203206



2020320



20203206

□



2020320

--	--	--	--	--	--	--	--



2020320



2020320



2020320



20203206



20203206



2020320



2020320



2020320

详见



□



2020320



20203206



20203206



20203206



20203200



2020320



20203200



2020320

□

业 总许 备



2020320

业 总 许 备



2020320

□



2020320



2020320



20203206



2020320



2020320



20203200



20203206



20203206



20203206

□



2020320





20203206



2020320



20203200

详见

详见



2020320

			□			



2020320



2020320

□					
					□
□					

□



2020320



20203206



2020320



20203206



20203206



20203206



2020320



2020320



20203200



20203200



2020320



20203200



20203206



20203206



2020320



20203206



2020320



20203200



2020320



20203200



20203206

认 员 监测 须 过 苏 环 厅组织 环 监测业务 认 监测 员 须 过 苏 环 厅组织 环 监测 术 员
仪 监测 监测仪 经过质检 门检 废 监测 废 监测 术规
污 监测质 证 质 术规 进



20203206

质监测 样 输 实验 处 污 监测 术规
污 监测质 证 质 术规 进
记录报 现场监测 实验 记录详细 监测 报 经 审

监测 记录 规 进 规 监测结



2020320

□ □ □ □





20203206



2020320



20203200

--



2020320



20203206



20203206

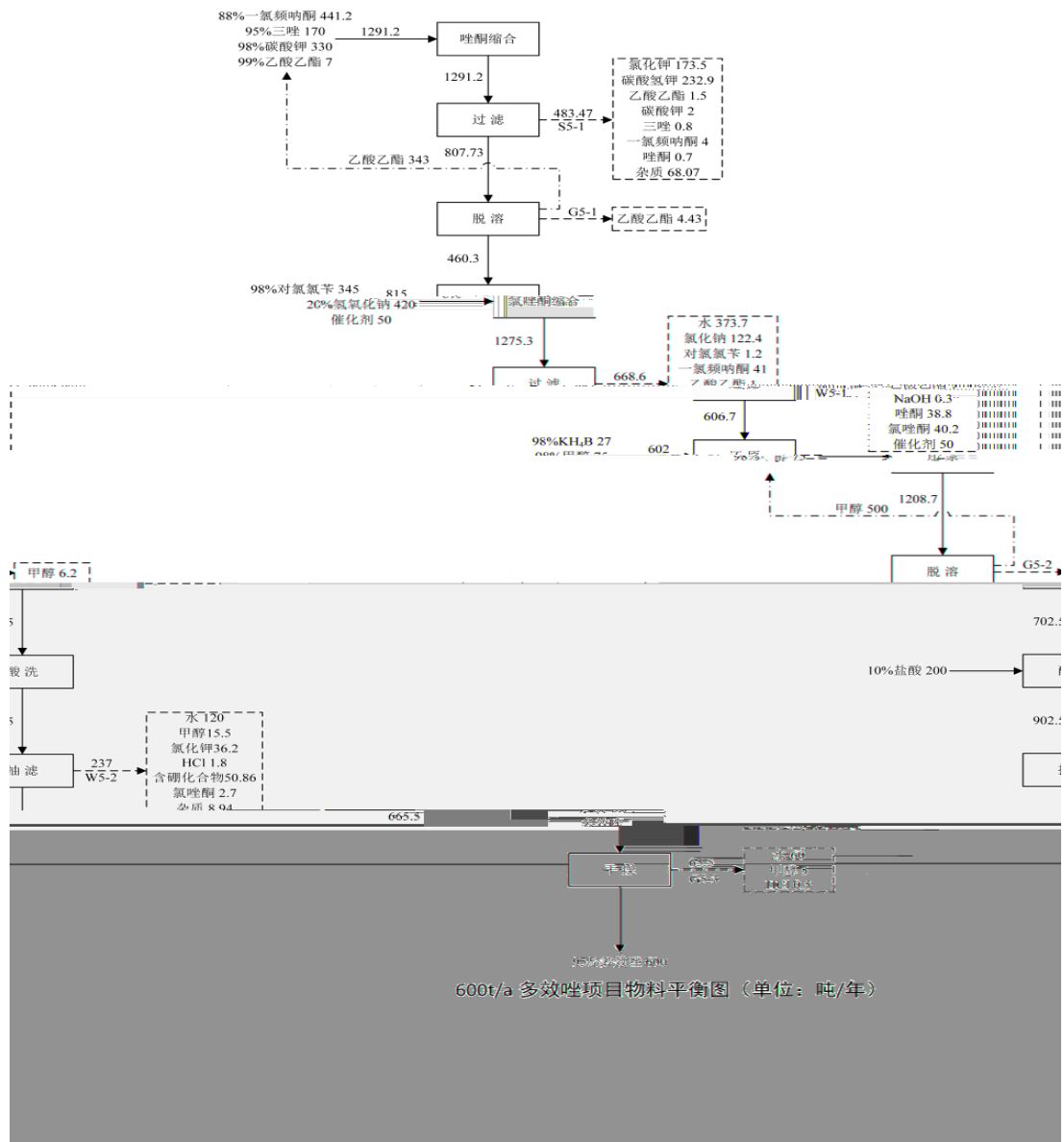

2020320

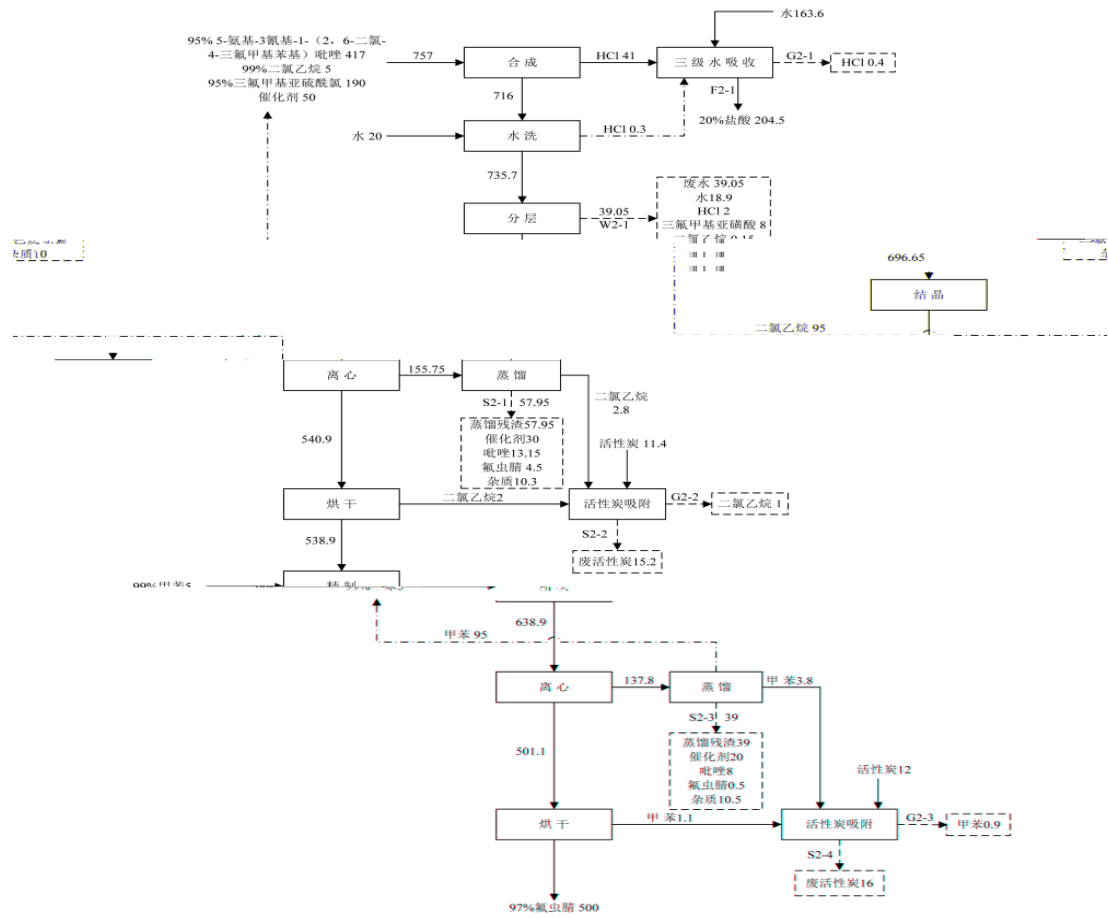

500t/a 氟虫腓项目物料平衡图 (单位: 吨/年)



2020320

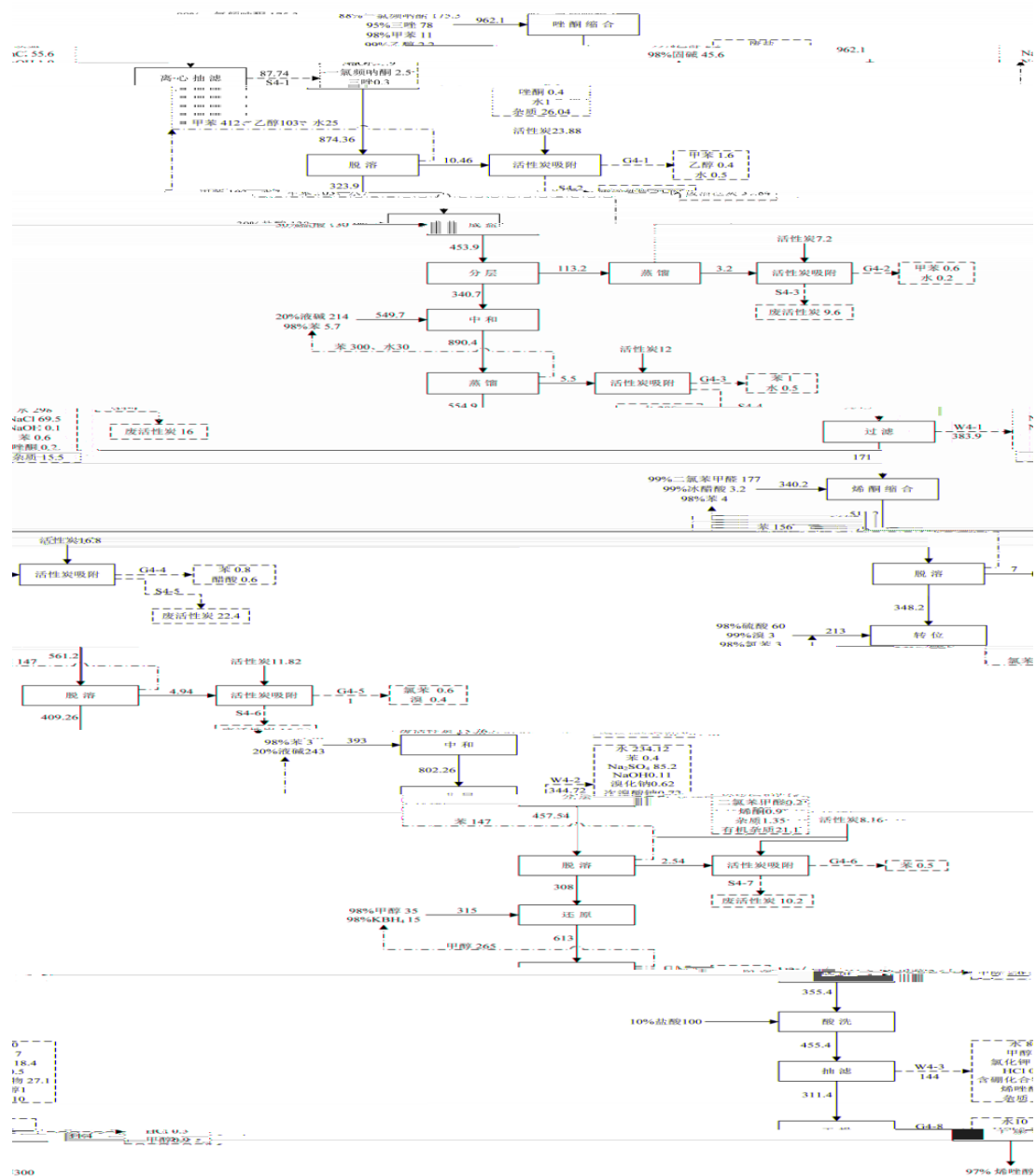

物料平衡图 (单位: 吨/年)

300t/a 咖啡因项目



2020320

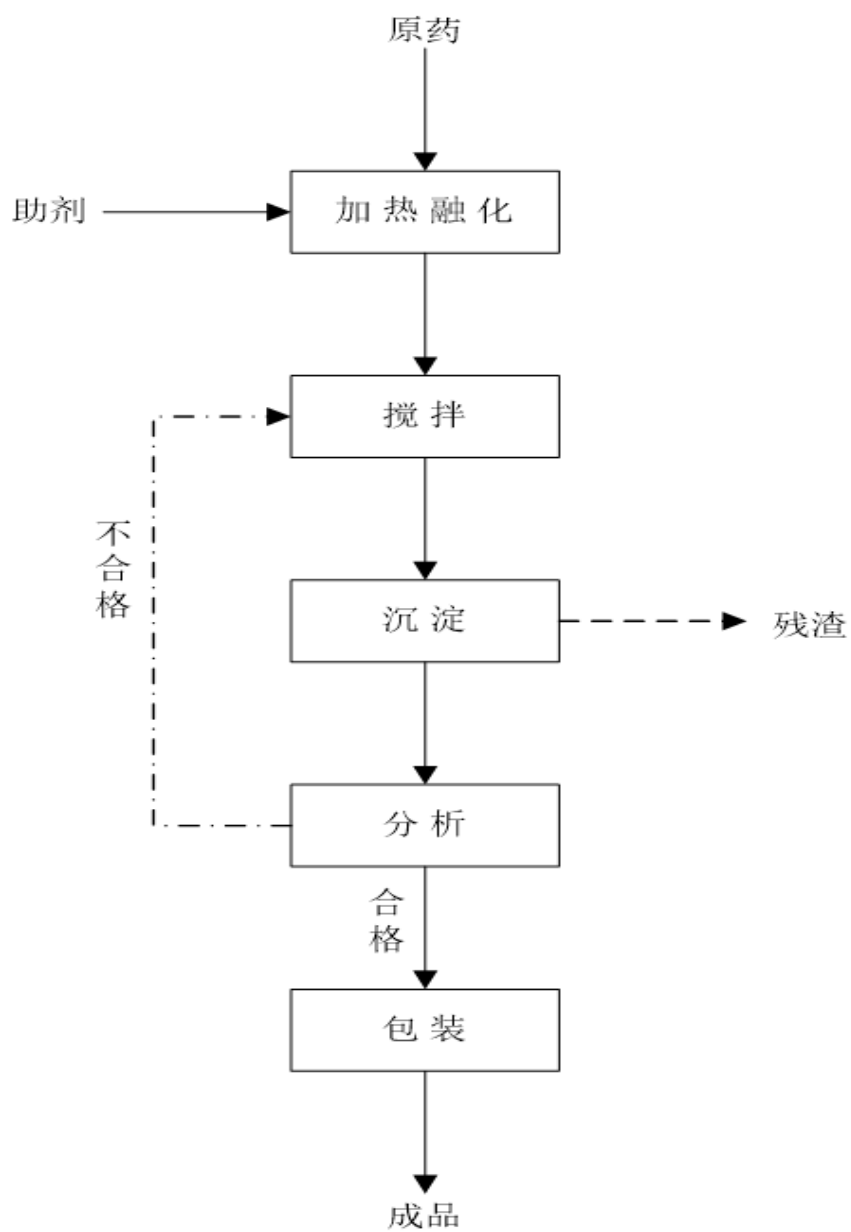

4500 吨液体乳油制剂生产工艺流程



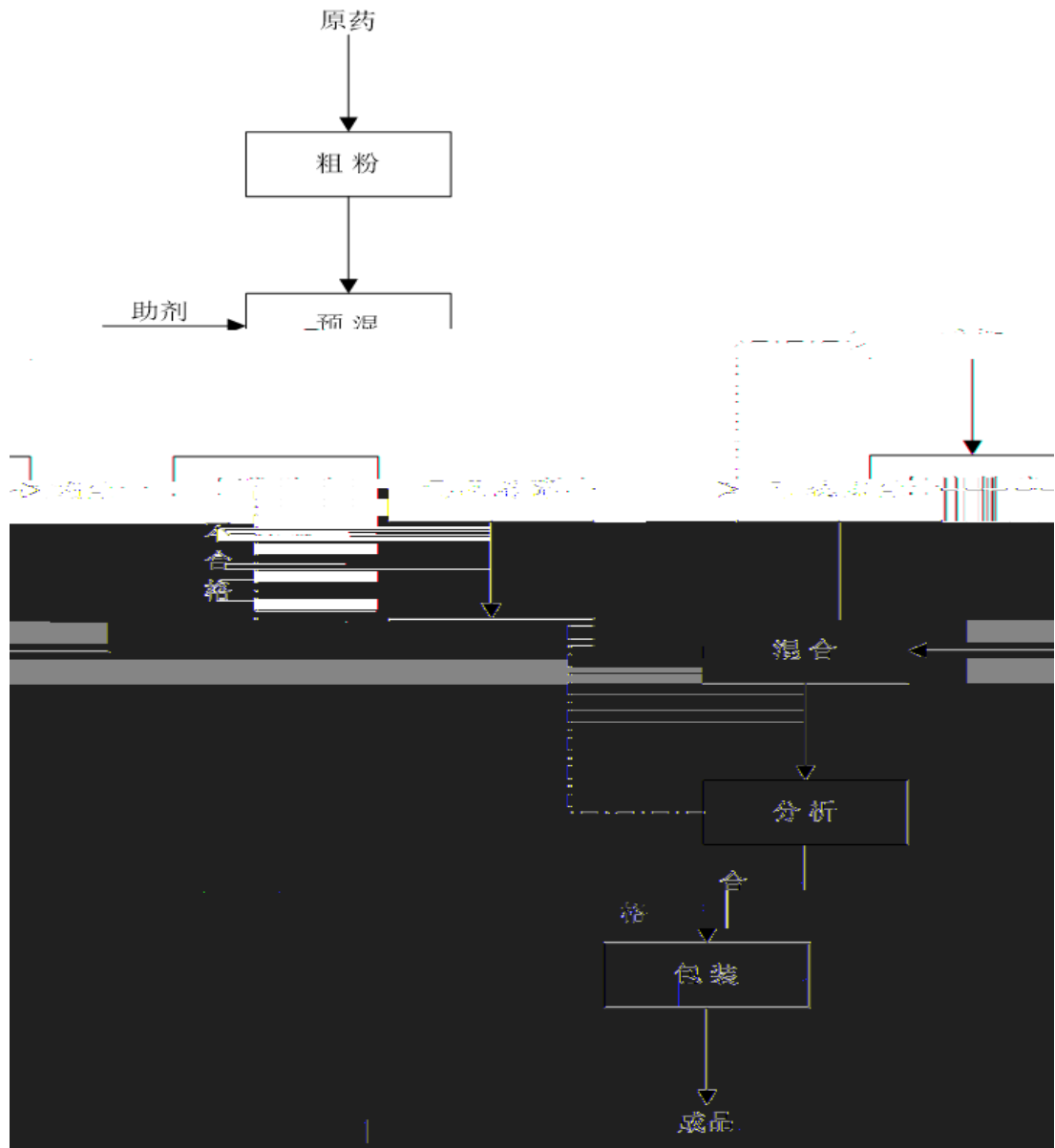

流程图

3200 吨粉剂剂生产工厂



2020320



托球农化总平面布置图



2020320

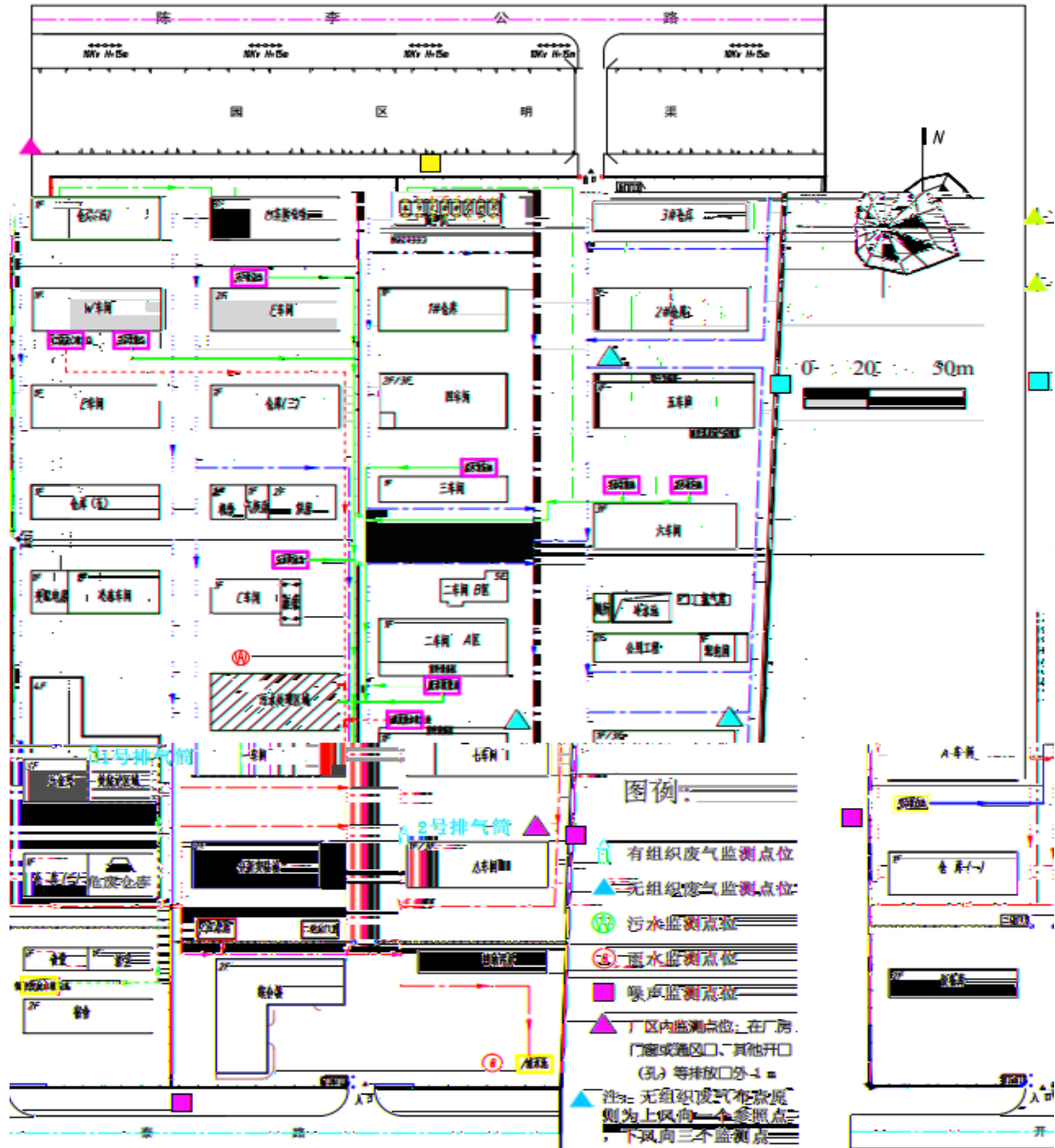

托球农化自行监测点位图



2020320

